

- If necessary, shorten the fixing bolts in order to suit the thickness of the door.
- When shortening the fixing bolts allow at least 4/5 threads to screw into the lock case.
- Locate the rubber seal behind the Digital Lock and using the fixing bolts secure the top and bottom of the Lock to the door.
- Before final tightening ensure the Lock is vertical and test mechanism to ensure that it is moving freely.
- Do not excessively tighten the Lock and seals to the door as it could damage the operation of the mechanism.

**Fixing Striker Plate**

- **IMPORTANT:** The striker must be positioned so that only the latch itself can enter the aperture but the anti-thrust must stop on the striker plate itself to maintain its anti-burglar function when the door is locked.
- Correctly position the striker plate, taking the above into consideration.
- Once the correct position is determined draw around the striker plate and mark the two holes.
- Remove the striker and cut a 1mm rebate to allow the striker to sit flush within the door frame.
- If necessary drill or cut a recess, at the correct position of the striker, for the Latch to enter when the door is closed.
- Drill the two, marked, holes for securing striker.
- Fix the striker with one screw first. Test the Lock to see if it works and is latching and locking correctly. If not proceed with any necessary adjustments before securing completely.
- If no adjustments are to be made completely secure striker with second screw.

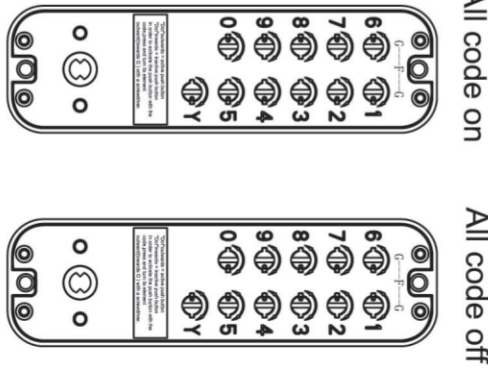

**Setting / Changing the Code**

- On the reverse of the Digital Lock Unit you will see slotted buttons which correspond to the push buttons on the front of the Lock.
- To set a button to operate within the code turn the slotted button relating to the number so that the dot is facing outwards (towards the 'G')
- To take a button out the code turn the slotted button so the dot is facing inward (towards the 'F')
- Check the code on the Lock functions before fitting to the door.

**Installation**

**Applying the Template**

- Correctly position and tape the template, T1035/SBL300, to the internal door face, at the desired height from the floor level. Ensure that the relevant, marked, door edge on template is correctly aligned with actual door edge. (Figure 1)
- Mark the 10mm diameter hole for the spindle of the Digital Lock, the two 7mm holes for the bolt through fixings.
- Mark the correct 6mm diameter hole, for the reinforcement pin, depending on the handling of the door.
- Drill all marked holes.

Figure 1

**Positioning of Spindle**

- The spindle is designed for doors 35 to 65 mm thick. Therefore shorten, if necessary, to suit door thickness.
- When inserting the spindle locate the end with the spring fitted into the Lever Handle Digital Lock on the external door face and the other end into the internal side.

**Fixing the Lock**

- **IMPORTANT:** Do not close the door before confirming that the code and lock is functioning correctly.

Figure 3

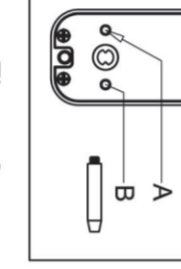
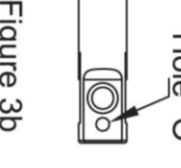

Figure 3b



**Installation of Reinforcement Pin**

- Screw the Bolt Guide in to Hole A for a door opening to the right (clockwise opening) (Figure 3)
- Screw the Bolt Guide in to Hole B for a door opening to the left (anti-clockwise opening) (Figure 3)
- The guide will locate in Hole 'O' of the latch to help maintain positioning. (Figure 3b)

Figure 2

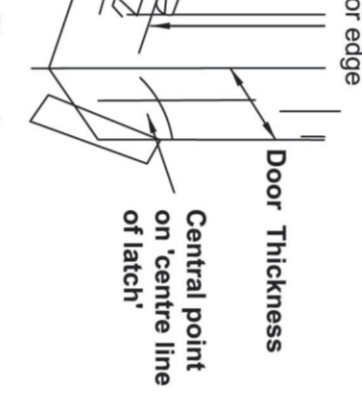

**Installation Instructions for DL3772 Push Button Lock With Lever Handle**

This lock has been Fire Tested in accordance with BS EN1643-1 with the use of Intumescent Seals.

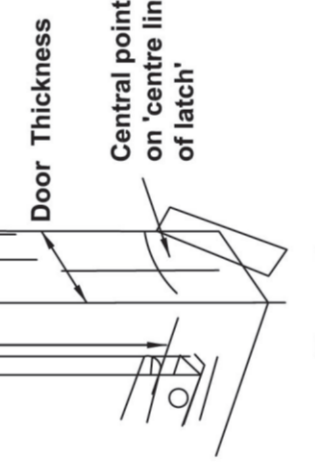

Figure 2



Figure 3b

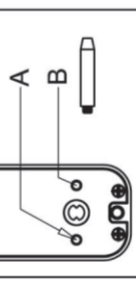

Figure 3

**Installing the Latch**

- Mark a central point on the 'centre line of latch' across the thickness of the door. (Figure 2)
- At the marked position drill a 25mm diameter hole x 80mm deep
- Insert Latch into the hole and draw around the face plate.
- Remove latch and cut a 3mm rebate to allow the Latch face plate to sit flush in the door.
- Secure latch with wood fixing screws ensuring the positioning is square.

**Installation of Reinforcement Pin**

- Screw the Bolt Guide in to Hole A for a door opening to the right (clockwise opening) (Figure 3)
- Screw the Bolt Guide in to Hole B for a door opening to the left (anti-clockwise opening) (Figure 3)
- The guide will locate in Hole 'O' of the latch to help maintain positioning. (Figure 3b)

**Positioning of Spindle**

- The spindle is designed for doors 35 to 65 mm thick. Therefore shorten, if necessary, to suit door thickness
- When inserting the spindle locate the end with the spring fitted into the Lever Handle Digital Lock on the external door face and the other end into the internal side.

**Fixing the Lock**

- **IMPORTANT:** Do not close the door before confirming that the code and lock is functioning correctly.

- If necessary, shorten the fixing bolts in order to suit the thickness of the door
- When shortening the fixing bolts allow at least 4/5 threads to screw into the lock case
- Locate the rubber seal behind the Digital Lock and using the fixing bolts secure the top and bottom of the Lock to the door.
- Before final tightening ensure the Lock is vertical and test mechanism to ensure that it is moving freely.
- Do not excessively tighten the Lock and seals to the door as it could damage the operation of the mechanism.

**Fixing Striker Plate**

- **IMPORTANT:** The striker must be positioned so that only the latch itself can enter the aperture but the anti-thrust must stop on the striker plate itself to maintain its anti-burglar function when the door is locked.

- Correctly position the striker plate, taking the above into consideration.
- Once the correct position is determined draw around the striker plate and mark the two holes.
- Remove the striker and cut a 1mm rebate to allow the striker to sit flush within the door frame.
- If necessary drill or cut a recess, at the correct position of the striker, for the Latch to enter when the door is closed.
- Drill the two, marked, holes for securing striker.
- Fix the striker with one screw first. Test the Lock to see if it works and is latching and locking correctly. If not proceed with any necessary adjustments before securing completely.
- If no adjustments are to be made completely secure striker with second screw.

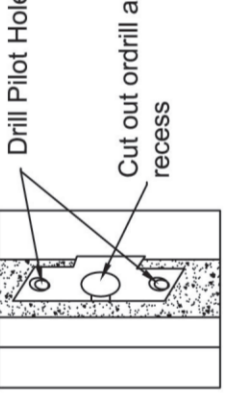
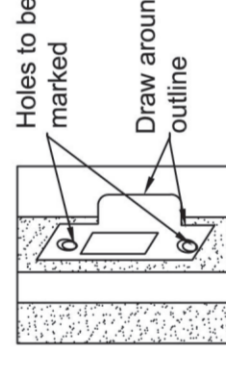

**Installation Instructions for DL3772 Push Button Lock With Lever Handle**

This lock has been Fire Tested in accordance with BS EN1643-1 with the use of Intumescent Seals.

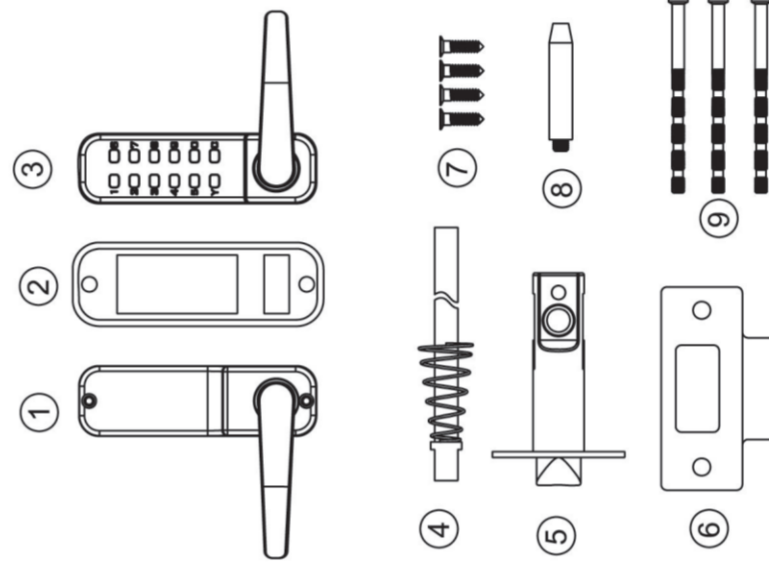

Figure 3

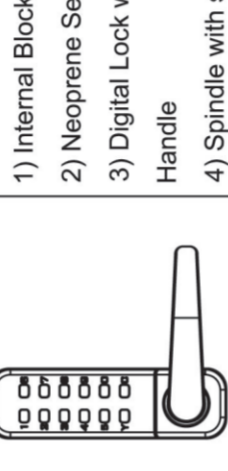

Figure 3b

LIST OF PARTS	BEFORE INSTALLATION PLEASE:
1) Internal Block	1) Ensure all parts work properly
2) Neoprene Seals x 2	2) Choose and set a code following the "Setting/Changing the Code" instructions. All or part of the push-buttons can be chosen in no particular order. Codes with 4 digits provide maximum security
3) Digital Lock with Lever Handle	3) Ensure that both lever handles of the Digital Lock can be moved freely. Also check that the latch moves freely by pressing the end and by turning with the spindle
4) Spindle with spring	
5) Latch (60mm standard)	
6) Striker Plate	
7) Wood screws x 4 (For securing Latch and Striker Plate)	
8) Bolt Guide	
9) Fixing Bolts x 3 (1 spare)	

**Setting / Changing the Code**

- On the reverse of the Digital Lock Unit you will see slotted buttons which correspond to the push buttons on the front of the Lock.
- To set a button to operate within the code turn the slotted button relating to the number so that the dot is facing outwards (towards the 'G')
- To take a button out the code turn the slotted button so the dot is facing inward (towards the 'F')
- Check the code on the Lock functions before fitting to the door.

**Installation**

**Applying the Template**

- Correctly position and tape the template, T1035/SBL300, to the internal door face, at the desired height from the floor level. Ensure that the relevant, marked, door edge on template is correctly aligned with actual door edge. (Figure 1)
- Mark the 10mm diameter hole for the spindle of the Digital Lock, the two 7mm holes for the bolt through fixings.
- Mark the correct 6mm diameter hole, for the reinforcement pin, depending on the handling of the door.
- Drill all marked holes.

Figure 1

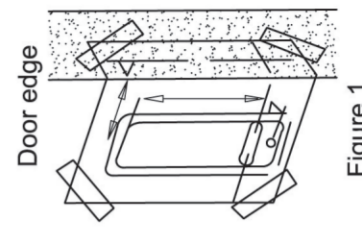
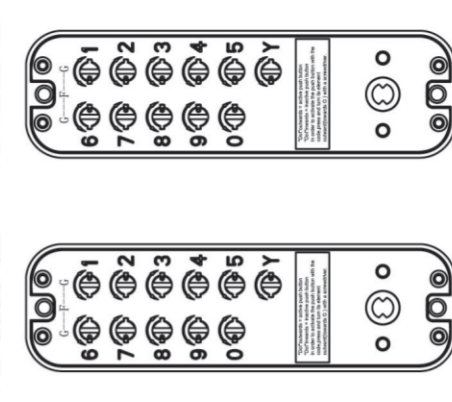

Figure 2