



YLI ELECTRONIC

Infrared Sensor Magnetic Lock

Model: YM-280IS(LED)



Specification

Lock Size	283Lx48.8Wx39.9H(mm)
Holding Force	280kg(600Lbs)
Voltage	DC12V (Adjustable DC24V)
Current	12V/500mA±10% 24V/250mA±10%
Signal Output	Lock signal(NO/NC/COM)
LED Indication	Red shows locked ;Green shows unlocked
Time Delay	3/6/9/12sec adjustable
Suitable for	Wooden door , Glass door ,Metal door , Fireproof door
Detection range	3m
Weight	2.6kg

Diagram(unit:mm)

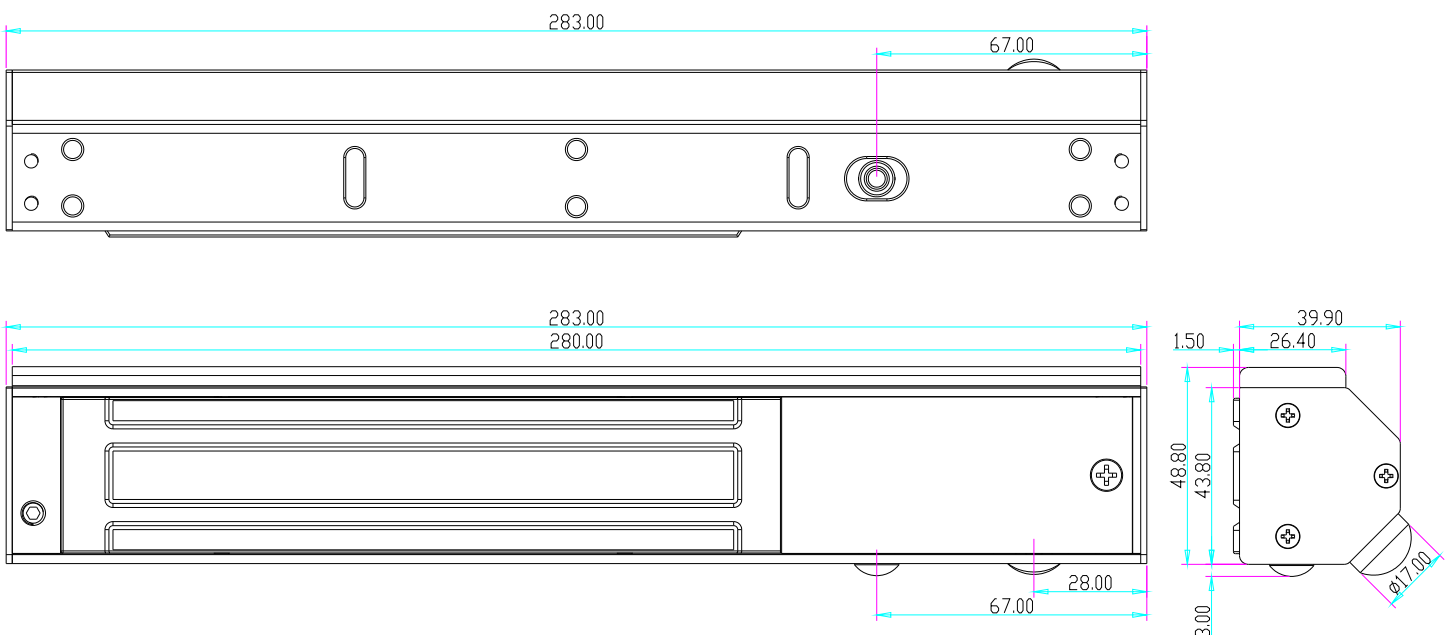

⚠ Cautions:

- The screw of armature plate should not be fixed too tight. Proper elasticity should be guaranteed for the rubber ring so that the armature plate can adjust itself to the appropriate position.
- Check the jumper's position before connecting. Figure out it represents 12V DC or 24V DC.
- Please keep the surface of the lock clean, or the force will be reduced because of the dust, glue or scotch tape on it.

Installation

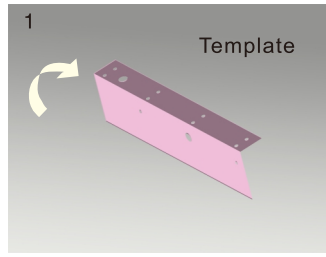
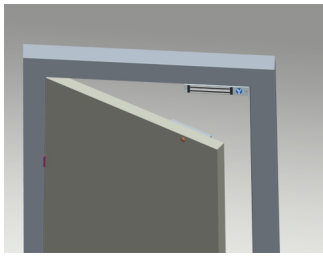

1 Fold the plate to 90° .

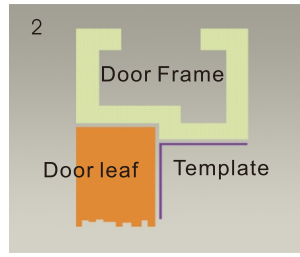

2 Close the door first, then place the upper side of template on door frame, while adjust the left side next to the door leaf.

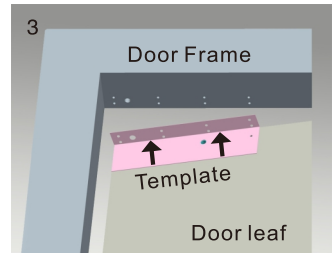

3 Mark screw positions of armature plate and magnetic lock on door leaf and door frame respectively.

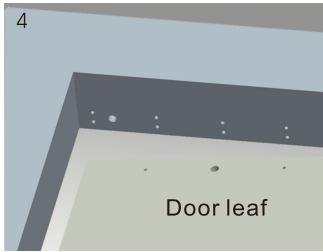

4 Drill holes based on the marked positions.

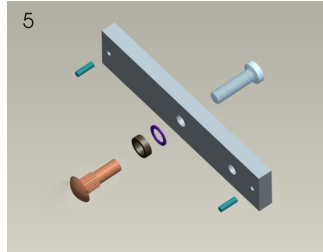

5 Make a combination based on the picture.

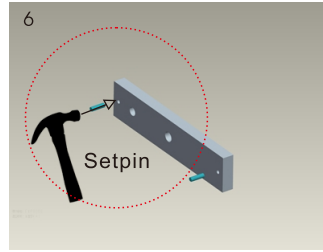

6 Strike the pin into the armature plate slightly (to avoid movement).

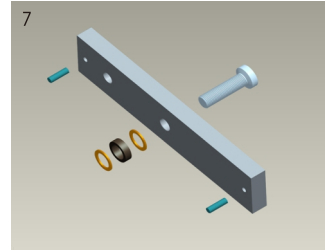

7 Make a combination based on the picture (add washer accordingly). The rubber ring must be added.

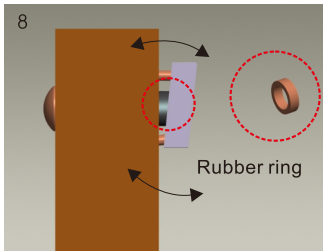

8 Place the rubber ring between armature plate and door leaf.

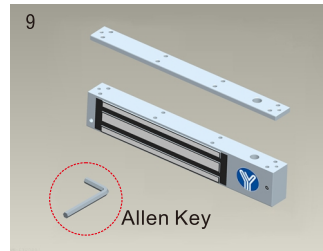

9 Use Allen key to remove the mounting plate from lock body.

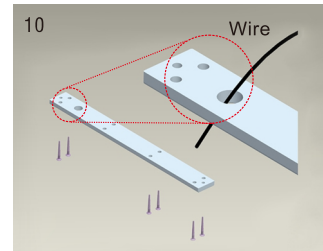

10 Fix the mounting plate on the door frame according to the holes drilled earlier.

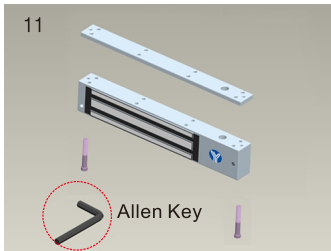

11 Use Allen key to screw the lock body on the mounting plate.

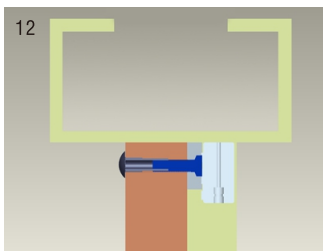

12 Close the door to test holding force. The angle between armature plate and magnetic lock can be adjusted by adding or reducing washers.

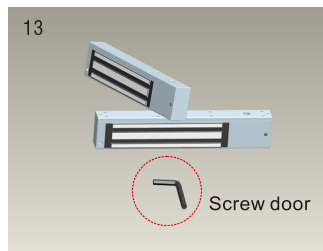

13 After all the appropriate procedures, the holding force can be maximized. Finally, fix the tamper screw.

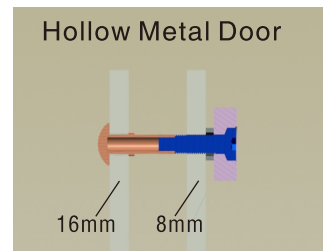

Hollow Metal Door

Drill a hole
Inside: Diameter is 8mm
Outside: Diameter is 16mm

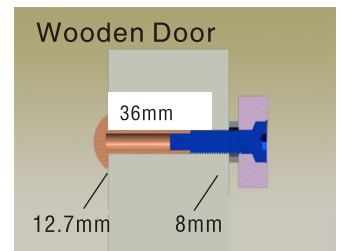

Wooden Door

Drill a hole
Inside: Diameter is 8mm
Outside: Diameter is 12.7mm

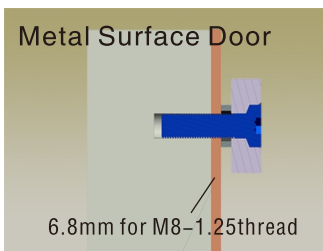

Metal Surface Door

6.8mm for M8-1.25thread

Inside: Drill a hole diameter is 8mm folding the plastic straight pin

Notice:

Thickness of Door Leaf:

350LBS: 44mm

600LBS: 50mm

800LBS: 48mm

1200LBS: 46mm

Circuit Board Diagram

A. 12VDC Input:

Required power 0.52 Amp(Minimum).
 Connect the positive(+)lead from a 12VDC power source to V +.
 Connect the ground(-)lead from a 12VDC power source to V -.
 Check jumper for 12 VDC operation.

B. 24VDC Input:

Required power 0.26Amp(Minimum).
 Connect the positive(+)lead from a 24VDC power source to V +.
 Connect the ground(-)lead from a 24VDC power source to V -.
 Check jumper for 24 VDC operation.

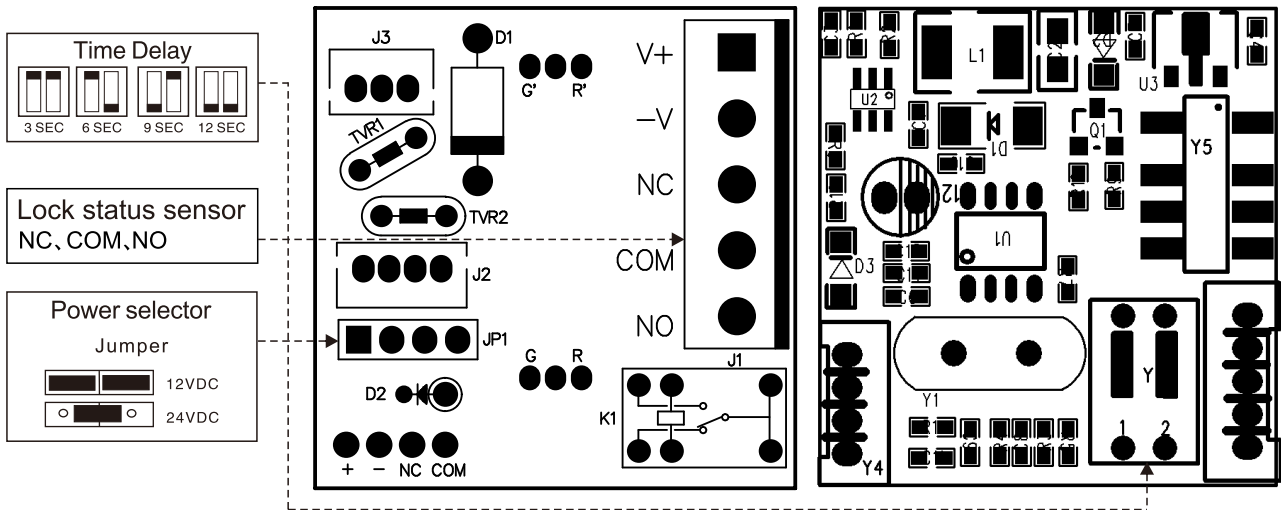

Wire Connection

