

## DS-2CD1141G0-I 4 MP Fixed Dome Network Camera



- High quality imaging with 4 MP resolution
- Easy installation with Power over Ethernet (PoE) technology

## ▪ Specification

Camera	
Image Sensor	1/2.8" Progressive Scan CMOS
Max. Resolution	2560 × 1440
Min. Illumination	Color: 0.01 Lux @ (F2.2, AGC ON), B/W: 0 Lux with IR
Shutter Time	1/3 s to 1/100,000 s
Day & Night	IR cut filter
Angle Adjustment	Pan: 0° to 355°, tilt: 0° to 75°
Lens	
Lens Type	Fixed focal lens, 2.8 and 4 mm optional
Focal Length & FOV	2.8 mm, horizontal FOV 104°, vertical FOV 57°, diagonal FOV 123° 4 mm, horizontal FOV 82°, vertical FOV 45°, diagonal FOV 98°
Lens Mount	M12
Iris Type	Fixed
Aperture	F2.2
Depth of Field	2.8 mm: 0.9 m to ∞ 4 mm: 1.1 m to ∞
DORI	
DORI	2.8 mm, D: 53 m, O: 21 m, R: 10 m, I: 5 m 4 mm, D: 67 m, O: 26 m, R: 13 m, I: 6 m
Illuminator	
Supplement Light Type	IR
Supplement Light Range	Up to 20 m
Smart Supplement Light	Yes
IR Wavelength	850 nm
Video	
Main Stream	50 Hz: 20 fps (2560 × 1440), 25 fps (1920 × 1080, 1280 × 720) 60 Hz: 20 fps (2560 × 1440), 24 fps (1920 × 1080, 1280 × 720)
Sub-Stream	50 Hz: 25 fps (1280 × 720, 640 × 480, 640 × 360) 60 Hz: 24 fps (1280 × 720, 640 × 480, 640 × 360)
Video Compression	Main stream: H.265+/H.265/H.264+/H.264, Sub-stream: H.265/H.264/MJPEG
Video Bit Rate	32 Kbps to 8 Mbps
H.264 Type	Baseline Profile, Main Profile, High Profile
H.265 Type	Main Profile
Bit Rate Control	CBR, VBR
Region of Interest (ROI)	1 fixed region for main stream
Network	
Security	Password protection, complicated password, watermark, basic and digest authentication for HTTP, security audit log, host authentication (MAC address)

Simultaneous Live View	Up to 6 channels
API	ONVIF (Profile S, Profile T), ISAPI, SDK
Protocols	TCP/IP, ICMP, DHCP, DNS, HTTP, RTP, RTCP, RTSP, NTP, IGMP, IPv4, IPv6, UDP, QoS, SNMP, DDNS
User/Host	Up to 32 users 3 user levels: administrator, operator, and user
Client	iVMS-4200
Web Browser	Local service: Chrome 80+, Firefox 80+, Edge 89+, IE 11
<b>Image</b>	
Wide Dynamic Range (WDR)	Digital WDR
SNR	≥ 52 dB
Privacy Mask	1 programmable polygon privacy mask
Day/Night Switch	Day, Night, Auto, Schedule
Image Enhancement	BLC, HLC, 3D DNR
Image Settings	Saturation, brightness, contrast, sharpness, gain, white balance, adjustable by client software or web browser
<b>Interface</b>	
Ethernet Interface	1 RJ45 10 M/100 M self-adaptive Ethernet port
<b>Event</b>	
Basic Event	Motion detection, exception
Linkage	Notify surveillance center, send email, trigger capture
<b>General</b>	
Power	12 VDC ± 25%, 0.4 A, max. 4.8 W, Ø5.5 mm coaxial power plug, reverse polarity protection, PoE: IEEE 802.3af, Class 0, max. 6.5 W
Material	Plastic
Dimension	Ø110.8 mm × 85.2 mm (Ø4.36" × 3.35")
Package Dimension	163 mm × 75 mm × 75 mm (6.4" × 3.0" × 3.0")
Weight	Approx. 240 g (0.5 lb.)
With Package Weight	Approx. 400 g (0.8 lb.)
Storage Conditions	-10 °C to 40 °C (14 °F to 104 °F). Humidity 95% or less (non-condensing)
Startup and Operating Conditions	-10 °C to 40 °C (14 °F to 104 °F). Humidity 95% or less (non-condensing)
Language	English, Ukrainian
General Function	Heartbeat, anti-banding, mirror, password protection, password reset via email
<b>Approval</b>	
EMC	CE-EMC: EN 55032: 2015, EN 61000-3-2:2019, EN 61000-3-3: 2013+A1:2019, EN 50130-4: 2011 +A1: 2014, KC: KN32: 2015, KN35: 2015
Safety	CB: IEC 62368-1: 2014+A11, CE-LVD: EN 62368-1: 2014/A11: 2017
Environment	CE-RoHS: 2011/65/EU, WEEE: 2012/19/EU, Reach: Regulation (EC) No 1907/2006

### ▪ Typical Application

Hikvision products are classified into three levels according to their anti-corrosion performance. Refer to the following description to choose for your using environment.

This model has NO SPECIFIC PROTECTION.

Level	Description
Top-level protection	Hikvision products at this level are equipped for use in areas where professional anti-corrosion protection is a must. Typical application scenarios include coastlines, docks, chemical plants, and more.
Moderate protection	Hikvision products at this level are equipped for use in areas with moderate anti-corrosion demands. Typical application scenarios include coastal areas about 2 kilometers (1.24 miles) away from coastlines, as well as areas affected by acid rain.
No specific protection	Hikvision products at this level are equipped for use in areas where no specific anti-corrosion protection is needed.

### ▪ Available Model

DS-2CD1141G0-I(2.8mm)

DS-2CD1141G0-I(4mm)



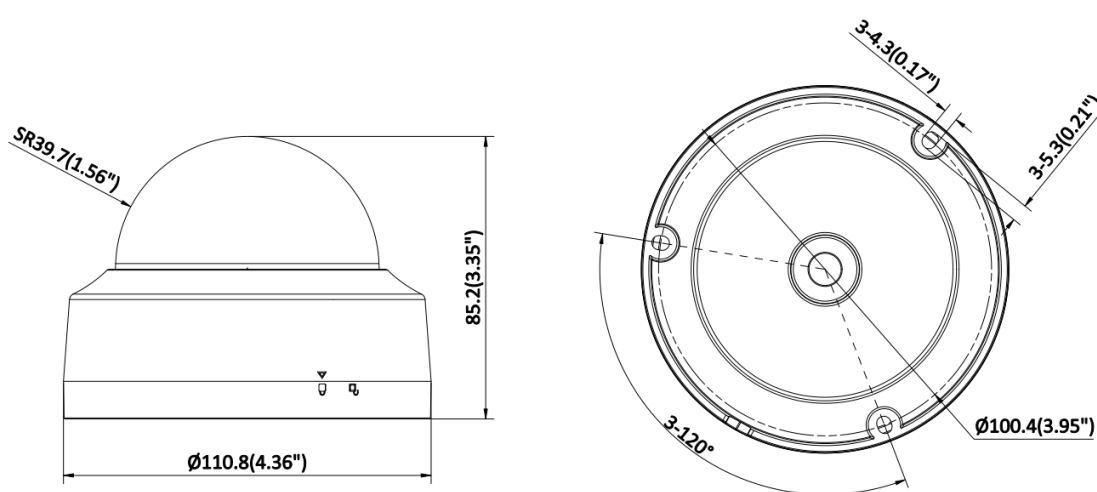















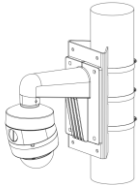



### ▪ Dimension

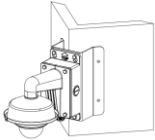

Unit: mm (inch)

▪ **Accessory**

▪ **Optional**

DS-1272ZJ-110B Wall mount	DS-1258ZJ Wall mount	DS-1272ZJ-110 Wall mount	DS-1271ZJ-110 Pendant Mount	DS-1275ZJ-SUS Vertical pole mount
				
				
DS-1276ZJ-SUS Corner mount	DS-1280ZJ-DM18 Junction box	DS-1259ZJ Inclined ceiling mount	DS-1250ZJ Water-proof	DS-2280ZJ-WA110 Junction box
				
				
DS-2210ZJ-WA-110 Pendant Mount	DS-2200ZJ-WA-110 Wall mount	DS-2200ZJ-WAJ-110 Wall mount		
				

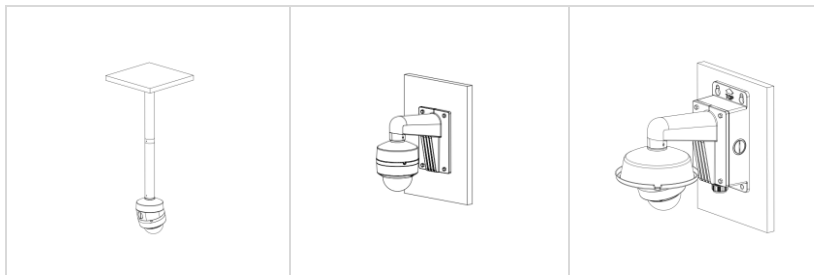

**Headquarters**

No.555 Qianmo Road, Binjiang District,  
Hangzhou 310051, China  
T +86-571-8807-5998  
www.hikvision.com



Follow us on social media to get the latest product and solution information.

